

PENTAX[®]

Instruction Manual

Electronic Total Station

R-300 SERIES

R-315(N)/R-325(N)/R-335(N)

R-322(N)/R-323(N)

PENTAX Industrial Instruments Co., Ltd.

PRECAUTIONS REGARDING SAFETY

Safety Precautions (Must be followed)

The following items are intended to prevent possible injury to the user or other people and/or damage to the instrument before it occurs. These safety precautions are important to the safe operation of this product and should be observed at all times.

Distinctive Displays

The following displays are used to distinguish precautions by the degree of injury or damage that may result if the precaution is ignored.

WARNING

Items indicated by this display are precautions which if ignored would result in serious injury.

CAUTION

Items indicated by this display are precautions which if ignored may result in injury or material.

- Here "injury" refers to injuries such as cuts, burns or electric shock the treatment of which will not likely require hospitalization or long-term attention.
- "Material damage" refers to damage to facilities, buildings, acquired data, etc.

Before using this product, be sure that you have thoroughly read and understood this instruction manual to ensure proper operation. After reading this manual, be sure to keep it in a convenient place for easy reference.

This instrument complies with the protection requirement for residential and commercial areas. If this instrument is used close to industrial areas or transmitters, the equipment can be influenced by electromagnetic fields.

- The description concerning only the Reflectorless type, R-315N/R-325N/R-335N/R-322N/R-323N, is put in ().

PRECAUTIONS REGARDING SAFETY•

WARNING

 Do not stare into the laser beam directly as this may result in damage to your eyes. R-300 is a Class II Laser product. The reflectorless type is a Class IIIa (3R) laser product.

 Do not look into the laser radiation aperture directly as this may result in damage to your eyes.

 Never use the telescope to view intense light such as direct sunlight or sun-light reflected through a prism as this may result in loss of sight.

 Do not disassemble, modify or repair this product as there a risk of laser radiation.

 Do not aim the laser beam at a person as it is harmful to the eyes and body.

Receive the examination treatment by the doctor when the eyesight or body trouble is doubted by any chance.

- **Electro-Magnetic Compatibility (EMC):**

This instrument complies with the protection requirement for residential and commercial areas. If this instrument is used close to industrial areas or transmitters, the equipment can be influenced by electromagnetic fields.

- Do not use this product in a coal mine, in a location where there is a coal dust, or near flammable material as there is a risk of explosion.

- Do not disassemble, modify or repair this product as there is a risk of fire, electric shock and burn injury. If you think the product requires repair, contact the retail outlet where you purchased it or an authorized repair site.

- Only use the BC03 battery charger intended for this product as the battery charger. Use of another battery charger entails a risk of fire or burn injury from the battery bursting into flames due to possible differences in voltage or polarity.

- Do not use a damaged electric cord plug or loose electric outlet when charging as there is a risk of fire or electric shock.

- Do not charge the battery while covered by clothes or similar item as there is a risk of fire if the clothes ignite.







- Do not use the battery or charger when wet as there is a risk of fire and burn injury due to short-circuit.

- To prevent making short-circuit when removing the battery and charger from the case and storing them, apply electrically resistant tape to the poles of the battery. Storing the battery and charger as-is may result in fire or burn injury due to short-circuit.

- Do not throw the battery into fire or expose it to heat as there is a risk of Injury if it explodes.

PRECAUTIONS REGARDING SAFETY•

CAUTION

-  For security, please do the opening inspection and inspection every a fixed period and adjustment.
-  When the laser beam enters eyes, an unexpected accident might be caused by the blink of eyes. Establish the laser product to avoid the height of eyes of a driving person and walker.
-  Establish an instrument so that laser beam does not hit a reflection thing as a mirror and a glass window. The refection beam of the laser is also harmful in the human body.
-  Besides the time when you measure the distance, cut off the power supply or shade the beam of aperture with caps.
-  Keep the laser product in the place where the person who does not have the product knowledge such as children does not touch by mistake.
-  Destroy the power supply mechanism of the instrument so as not to emit the laser beam when throwing away it.
- Do not remove the handgrip without good reason. If it does come off, be sure to attach it securely to the instrument with screws. If it is not fastened securely, the instrument may fall when you grasp the handgrip, leading to possible injury.
- Do not short the poles of the battery or charger as there is a risk of injury or fire.
- Do not touch any fluid which may leak from the battery as there is a risk of chemical burn injury or reaction.
- Do not insert or remove the electric plug with wet hands as there is a risk of electric shock.
- Do not use the case to stand on as it is slippery and unstable and may cause you to fall, resulting in possible injury.
- Be sure the tripod itself and the instrument on the tripod are both installed securely as insecure installation may cause the tripod to fall over or the instrument to drop, resulting in possible injury.
- Do not carry the tripod with the metal shoe pointing toward another person as the person may be injured if they strike him or her.



- The instrument contains a rechargeable battery and it is rechargeable.
- At the end of its useful life, it may be illegal to dispose of the battery.

- Check with your local solid waste officials for details for recycling.

P2

Usage Precautions

Surveying instruments are high-precision instruments. In order to assure that the Electronic Total Station R-300 series product which you have purchased will provide long-lasting maximum performance, the precautions in this manual must be followed. Be sure to follow these instructions and use this product properly at all times.

[Solar Observation]

WARNING

Never view the sun directly using the telescope as this may result in loss of sight. Never point the objective lens directly at the sun as this may damage internal components. When using the instrument for solar observation, be sure to attach the special solar filter (MU64) designed for this product to the objective lens.

[Laser Beam]

 Do not stare into laser beam. R-300 is a class-II Laser product. The reflectorless type is a Class IIIa (3R) laser product.

[EDM axis]

The R series EDM is the red visible laser beam and the beam diameter is very small. The beam is emitted from the objective center. The EDM axis is designed to coincide with the telescope sight axis but both axes may not sometimes coincide slightly according to the intense temperature change and time lapse.

[Target Constant]

Confirm the Target Constant of the instrument before measurement.

If a different constant is to be used, use the correct constant of the target. The constant is stored in the instrument's memory when turned off.

[Reflectorless and Reflector sheet]

- The measurement range is determined by the white side of the Kodak Gray Card facing the instrument and by its surrounding brightness.

There is a possibility that the range may vary when the target does not satisfy the conditions above at survey work.

- Pay attention to followings in case of distance measurement by Reflectorless.

In case of resulting in low accuracy, perform the distance measurement by Reflector sheet or Prism. (R-315N/R-325N/R-335N/R-322N/R-323N)

There is a possibility that correct distance measurement may be impossible by dispersion or reduction of laser beam when the laser beam comes into the target from diagonal angle.

There is a possibility that the instrument cannot calculate correctly when receiving reflected laser beam from forth and back directions in case of measuring the target on the road.

P3

PRECAUTIONS REGARDING SAFETY•

There is a possibility that synthesized values are calculated and the distance may become longer or shorter than the actual one when the operator measure the target of slope or sphere or rugged shape.

There is a possibility that the instrument cannot calculate correctly by collecting the reflected laser beam from a man or a car that comes and goes in front of the target.

- When using Reflector sheet, set the Reflector sheet to have its surface be approx. vertical to the aiming line. If it is positioned not to be approx. right angle, there is a possibility that correct distance measurement may be impossible by dispersion or reduction of laser beam.

[Battery & Charger]

Never use any battery charger other than the BC03 battery charger as this may result in damage to the instrument.

If water should happen to splash on the instrument or the battery, wipe it off immediately and allow it to dry in a dry location. Do not put the instrument in the case until it is completely dry as this may result in damage to the instrument.

Turn off the power when removing the battery from the instrument as removing the battery while the power is still on may result in damage to the instrument.

The battery mark displayed on the instrument is only an estimate of remaining battery power and is not completely accurate. Replace the battery quickly when it is about to run down as the time a battery lasts on one charge differs depending on conditions of ambient temperature, and the measurement mode of the instrument.

Confirm the battery level remaining before operating.

[Auto focus]

The Auto focus mechanism is very precise but will not function under every condition. Focusing depends on brightness, contrast, the shape and size of the target.

In such a case, press the AF button and focus on the target by operating the Power focus key or the AF ring.

[LD POINT, Laser pointer]

When you make a correct direction using the "LD POINT", aim the laser beam at the wall and mark the center and then confirm the discrepancy between the reticle center and the marked point beforehand.

[Storage and Operating Environment]

To prevent making short-circuit when removing the battery and charger from

the case and storing them, apply electrically resistant tape to the poles of the battery. Storing the battery and charger as is may result in fire or burn injury due to short-circuit.

P4

PRECAUTIONS REGARDING SAFETY

- Avoid storing the instrument in places subject to extreme high, low or radically fluctuating temperature. (Ambient temperature range during use: -20 ° C to +50 ° C)
 - Distance measurements may take longer when atmospheric conditions are poor such as when heat shimmer is present. When storing the instrument, always put it in its case and avoid storage in dusty location or location subject to vibration or extreme heat or humidity.
 - Whenever there is a sharp temperature difference between the instrument's storage and usage locations allow the instrument to adjust to the ambient for an hour or more before use. Be sure to protect the instrument from the sun if the location is subject to intense direct sunlight.
 - During surveys for which the survey precision or atmospheric measurement method has been defined measure the atmospheric temperature and pressure separately and enter those values rather than using the Automatic Atmospheric Correction function.
 - The battery should be charged approximately once per month if the instrument is to be stored for an extended period of time. The instrument should also be removed from its case occasionally and aired out.
- In addition to these precautions, be sure to handle the instrument properly at all times following the descriptions given in the various sections of this manual to assure safe and proper measurements.

[Transporting and Carrying the Instrument]

Be careful to protect this instrument from shock of impact and excessive vibration which may result in damage during transportation and shipment. When transporting the instrument, always put it in the case and wrap shock-absorbing material around it and be sure it is handled as "FRAGILE".

[Checks and Repairs]

Always check the instrument before beginning work and check that the instrument is maintaining the proper level of precision. Pentax bears absolutely no responsibility for damages due to survey results obtained from surveys conducted without an initial instrument check. Never disassemble the instrument, battery or charger even if you do detect an abnormality as there is a risk of fire or electric shock due to short-circuit. If you think the product requires repair, contact the retail outlet where you purchased it or an authorized repair site.

P5

CONTENTS

PRECAUTIONS REGARDING SAFETY

Safety Precautions

Usage Precautions

CONTENTS

1 BEFORE USING THE INSTRUMENT

1-1 Names of Parts

1-2 Unpacking and Packing

1-2 Standard equipment

1-4 Attaching and Charging the Battery

1-5 Attachment of Focus Battery

2 DISPLAY AND KEYBOARD

2-1 Display and Keyboard

2-2 Operation Key

2-3 Function Key

2-4 Alphanumeric Input

2-5 LD Point, Laser pointer

3 PREPARATION FOR SURVEYING

3-1 Centering and Leveling of the Instrument

3-2 Laser Plummet

3-3 Optical Plummet..(Option)

3-4 .Leveling with Circular Vial

3-5 Leveling with Electronic Vial

3-6 Eyepiece Adjustment

3-7 Target Sighting

3-8 Attachment and Detachment of Tribrach

4 TURNING THE POWER ON

4-1 Turning the Power On and Off

4-2 Adjusting LCD Contrast

4-3 Adjusting Illumination Brightness

4-4 Adjust Reticle Illumination

P6

1 BEFORE USING THE INSTRUMENT

1 BEFORE USING THE INSTRUMENT

1-1 Names of Parts

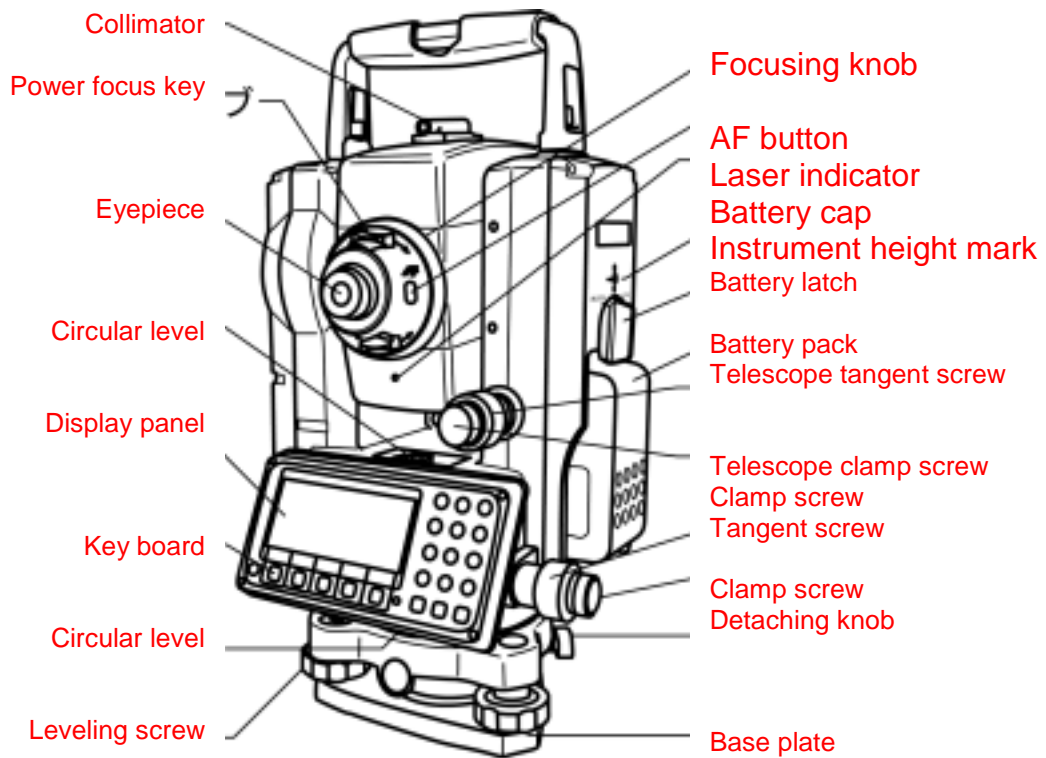

R-325(N)/R-322(N)/R-323(N): Detachable type

P7

1 BEFORE USING THE INSTRUMENT

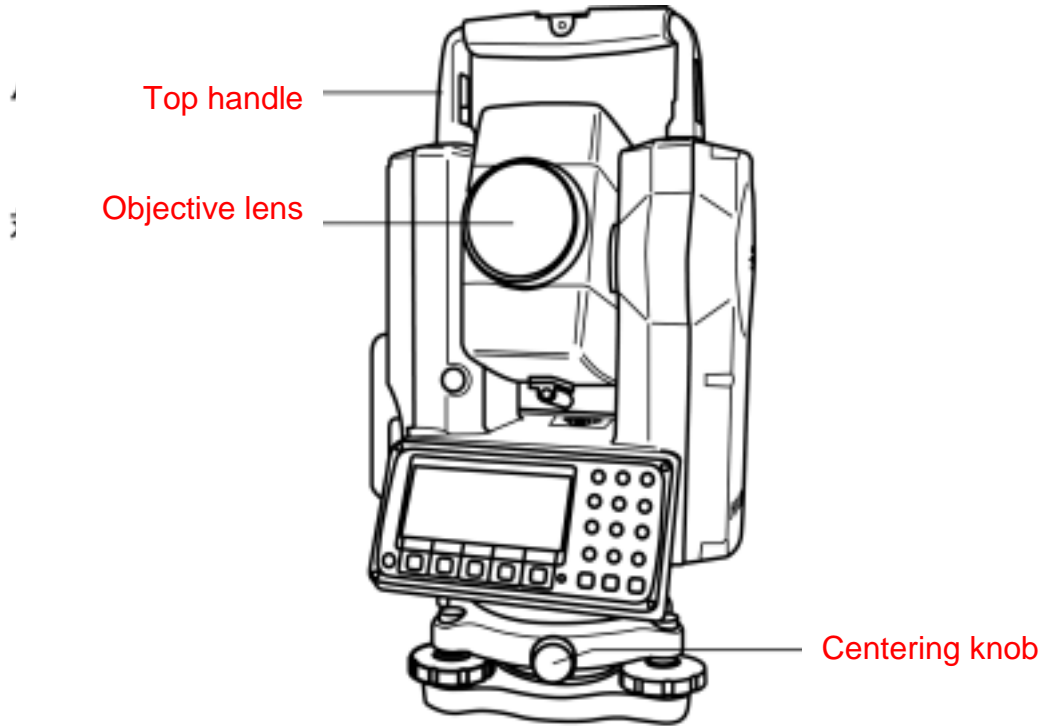

R-335 (N): Shift type

P8

1-2 Unpacking and Packing

Unpacking the Instrument from the case

- q Set the case down gently with the lid facing upwards.
- w Open the latches while pressing down on the lock (safety mechanism) and open the lid of the case.
- e Remove the instrument from the case.

Packing the Instrument in the case

- q Make sure the telescope is fairly level and lightly tighten the telescope clamp screw.
- w Line up the housing marks (round yellow marks on the instrument) and tighten the upper and lower clamp screws.
- e With the housing marks facing upward, set the instrument gently in the case without forcing it.
- r Close the lid to the case and secure the latches.

1-3 Standard equipment

- Instrument
- Carrying case
- BP02 battery
- BC03/AC01 charger
- AF battery (CR-123A)
- Plumb bob
- Hexagonal wrench
- Rain cover
- Quick Reference Guide (Basic , PTL and PCS 330 procedures)
- CD-R (Basic operation & Special Functions manual)

P9

1 BEFORE USING THE INSTRUMENT•

1-4 Attaching and Charging the Battery

Removing the Battery

Turn the lock lever anticlockwise and remove the Battery.

Lift up the battery pack and remove it from the instrument.

- Be absolutely sure to turn the power off when removing the battery as removing the battery while the power is still on may result in damage to the instrument.

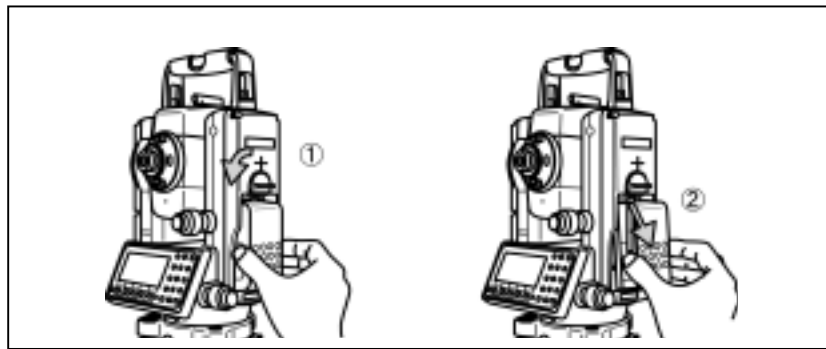

Attaching the Battery

Align the guide pins on the battery pack with the guide grooves on the instrument and push the battery pack down into place.

The battery is attached when you hear the top of the battery pack click into place.

Turn the lock lever clockwise to fix.

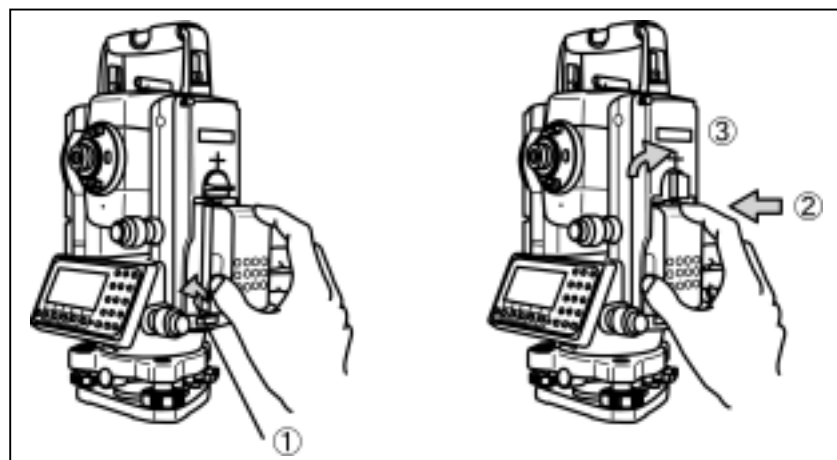

P10

1 BEFORE USING THE INSTRUMENT

Remaining Battery Charge

When the instrument's power is turned on, a battery mark "" will be displayed on the right of the display screen. This mark can be used to check the charge status of the battery.

Low battery: Please change. Replace with the spare battery or charge.

Charging the battery

- The battery BP02 is not charged at our factory shipment so charge it.
- For BP02 charge, use the special BC03 charger.

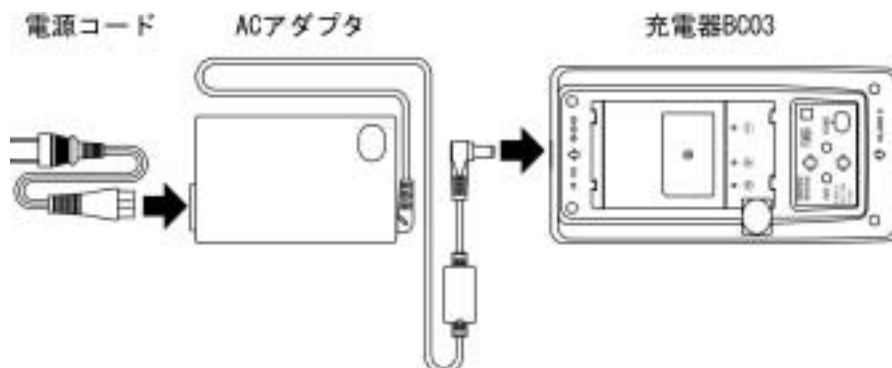

[Connection of code]

Insert the output plug of the power supply code in Jack of the AC adaptor.

Insert the output plug of the AC adaptor in Jack of the charger.

Insert the power supply plug of the power supply code in the outlet of domestic use AC power supply (100V,50Hz-60Hz).

[Installation of battery]

Draw the battery to the lock lever side and put it on the battery pocket. The battery is

posite direction of the lock lever.

code" is done, the charge with the

battery is begun.

P11

[Detaching of battery]

Press the lock lever and slide the battery to the lock lever direction.
Detach the battery packing from the battery pocket.

[Display panel]

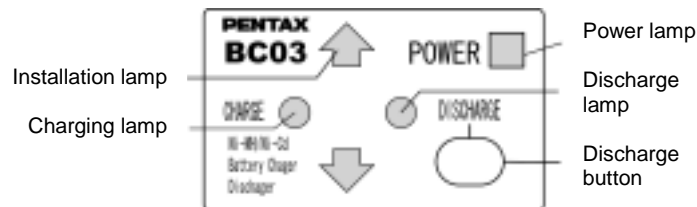

Power supply lamp (red): Turns on when the power supply is turned on.

Charge lamp (green): Turns on while charging and turns off when the charge is completed.

Discharge lamp (yellow): Turns on when you push the discharge button.

Turns off when the discharge is completed. .

Installation lamp (red): Blinks or turns on when the battery packing is attached normally.

Blinks when charge or discharge and turns on when charge is completed.

(The charge lamp in the lower does not blink and does not turns on)

Discharge button: Discharge lamp lights when you push this button, and the discharge of battery begins.

P12

[How to charge]

It begins charging automatically when you set the battery packing in the charger which beams the power supply lamp.

Leave just as it is until the charge is completed.

When the charge is completed, the charge lamp is turned off.

Detach the battery packing from the charger when the charge is completed.

Refreshing of battery

The use time shortens gradually by the phenomenon of "Effect of the memory" when the NiMH battery leaves capacity and repeats the charge. The voltage recovers after refreshing and the use time returns normally in such a battery. Please refresh one degree every five times of the charge.

[Refreshing]

Set the battery in the charger as well as the case of the charge. Push the electrical discharge button. The electrical discharge lamp lights and the electrical discharge begins.

The electrical discharge lamp is turned off when the electrical discharge ends, the charge lamp lights, and the charge starts automatically. Leave just as it is until the charge is completed. When the charge is completed, the charge lamp is turned off. Detach the battery from the charger.

[Time of refreshing and charge]

Battery BP02 is discharged from the state of a full charge at about 960 minutes and the charge is completed from the electrical discharge at about 130 minutes. However, the electrical discharge time is proportional to the remainder capacity of the battery. Moreover, the time required for refreshing might be different from the above-mentioned time according to a surrounding temperature and the state of the battery.

P13

2 DISPLAY AND KEYBOARD

2-1 Display and Keyboard

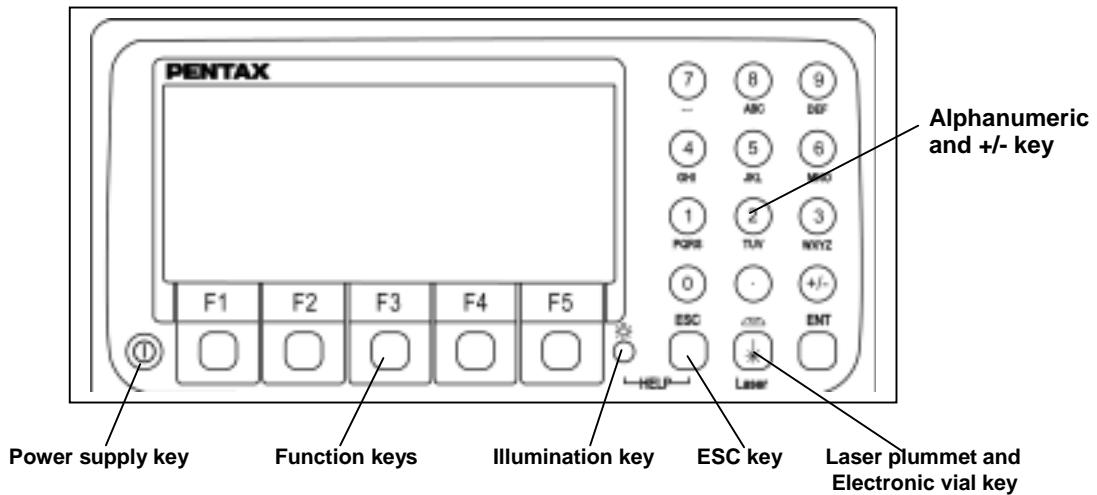

2-2 Operation Key

Key	Description
[POWER]	ON/OFF of power supply
[ESC]	Returns to previous screen or cancels an operation.
[Illumination]	Turns the illumination of the LCD display and telescope reticle on and off.
[ENT]	Accepts the selected (highlighted) choice or the displayed screen value.
[Laser]	Displays the laser plummet *1, electronic vial function, and the LD point screen when you push the laser plummet/electronic vial key. (Refer to "5-3 LD point function", "9-1-2 Laser plummet", and "Leveling with 9-1-4 electron vial"). *1:Only the product with the laser plummet function
[Alphanumeric]	At the numerical value screen, the numerical value and the sign '.' displayed are input. The English characters printed right under numeric of each key are input.
[HELP]	Pressing [ILLU]+[ESC] key causes a help menu to appear in A MODE or B MODE or causes a help message to appear.

P14

2 DISPLAY AND KEYBOARD

2-3 Function Key

Display	F. Key	Description
Mode A		
「 MEAS 」	F1	Pressing this key one time measures the distance and measurement type can be selected by Initial Setting 2. Pressing this key twice measures the distance by cm unit and another measurement type can be selected by Initial Setting 2.
[TARGET]	F2	Select the target type by following order. SHEET/ REFLECTORLESS /PRISM (Reflectorless type instrument) SHEET/PRISM/REFLECTORLESS (Prism type instrument)
[0 SET]	F3	Resets the horizontal angle to 0 ° 0' 0" by pressing twice.
[DISP]	F4	Switches the display composition in the order "H.angle/H.dst./V.dst.", "H.angle/V.angle/S.dst." and "H.angle/V.angle/H.dst./S.dst./V.dst.".
[MODE]	F5	Switches the screen between MODE A and MODE B.
Mode B		
[S.FUNC]	F1	PowerTopoLite
[ANG SET]	F2	Brings up the angle setting screen for setting angle-related parameters (H.ANGLE/%GRADE, H.ANGLE INPUT and R/L REVERSE).
[HOLD]	F3	Pressing this key twice retains (holds) the horizontal angle shown on the display.
[CORR]	F4	Brings up the screen for changing the Target constant, Temperature, Pressure setting.
Other functions		
[]	F1	Moves the cursor to the left.
[]	F2	Moves the cursor to the right.
[]	F1	Goes back five items on the screen
[]	F2	Goes forward five items on the screen.
RETICLE	F3	Changing the Reticle illumination when pressing Illumination key
[]	F3	Moves the cursor up
LCD	F4	Changing the LCD contrast when pressing Illumination key
[]	F4	Moves the cursor down
ILLU	F5	Changing the LCD illumination when pressing Illumination key
[CLEAR]	F5	Clear the figure
[SELECT]	F5	Open the selection window

P15

[How to move the menu number]

Example:

The cursor is located at Menu 1.

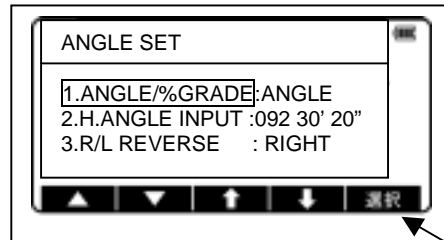

Press the numeric key **0** and **2** to move to Menu 2.

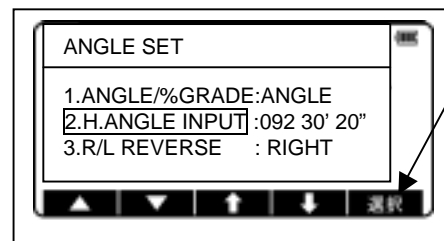

SELECT

P16

2 DISPLAY AND KEYBOARD

2-4 Alphanumeric Input

The point name is input by the Alphanumeric keys as following.

Key	Letter under Key	Letter & Figure order to input
[0]		[@][.][_][-][:]/[0]
[1]	PQRS	[P][Q][R][S][p][q][r][s][1]
[2]	TUV	[T][U][V][t][u][v][2]
[3]	WXYZ	[W][X][Y][Z][w][x][y][z][3]
[4]	GHI	[G][H][I][g][h][i][4]
[5]	JKL	[J][K][L][j][k][l][5]
[6]	MNO	[M][N][O][m][n][o][6]
[7]	-	[空白][?][!][_][][^][]&[7]
[8]	ABC	[A][B][C][a][b][c][8]
[9]	DEF	[D][E][F][d][e][f][9]
[.]		[.][,][:][#][()]
[+/-]		[+][-][*]/[%][=][<][>]

2-5 LD POINT, Laser Pointer

The Laser pointer function appropriates the laser beam to aiming point and the watching confirmation can be done.

When the [LD POINT] key is pushed while pushing the [Laser] key, the Laser pointer function is turned on. The distance measuring beam lamp blinks and the “ ● ” mark on the left of the screen blinks while the Laser pointer function is operating.

If the [Laser] key is pushed and the [LD POINT] key is pushed while the Laser pointer function is operating, the Laser pointer function is turned off.

The beam of the sun is strong and the watching confirmation is difficult at daytime outdoor.

The laser beam is designed as the beam cannot be watched from eyepiece.

Please appropriate the laser beam to the wall and mark the center, and confirm the amount of the gap (horizontal angle and vertical angle of a cross line) beforehand when working like accurately putting out the direction by using the Laser pointer function.

Please do not look at the laser source of beam directly.

This product is Class 2 of the laser safety standard of JIS “ Radiation safety standard of the laser product”.

P17

3 PREPARATION FOR SURVEYING

3 PREPARATION FOR SURVEYING

3-1 Centering and Leveling of the Instrument

Setting up the instrument and the tripod

Adjust the tripod legs so that a height suitable for observation is obtained when the instrument is set on the tripod.

Set the tripod and fix the metal shoes firmly into the ground so that the tripod head is as level as possible, and the Tripod head coincides with the station on the ground. Fasten the leg screws.

If the tripod head is mis-leveled by the action of fixing the metal shoes into the ground, correct the level by extending or retracting each leg of the tripod.

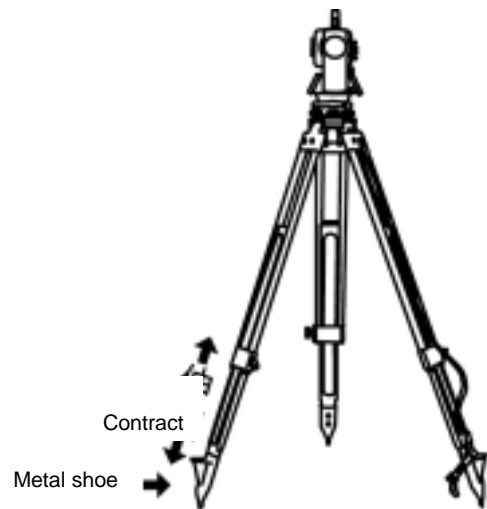
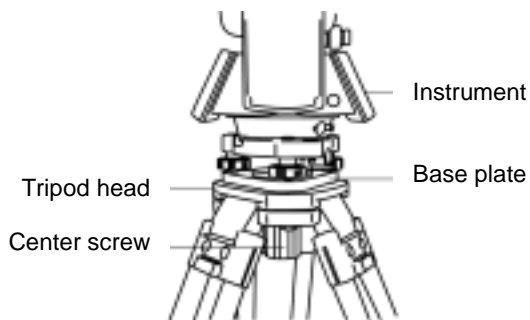

3 PREPARATION FOR SURVEYING

3-2 Laser plummet

Laser plummet model

The laser plummet is not set to be ON at factory shipping. The laser plummet operation of power supply ON can be set by command No520, LD PLUM & E VIAL.

[For the Detaching type laser plummet equipment model]

Turn on the laser plummet function by pushing the Laser key.
Match the position with the leveling screw so that the laser mark may come on ground mark.

[For the Shift type laser plummet equipment model]

- Turn on the laser plummet function by pushing the Laser key.
- Match the position by the tripod so that the laser mark may come on the ground mark.
- The plumb fixation screw is loosened, and the upper plate is pushed by the tip of a finger, and a central mark is matched to the ground mark.
- Tighten the plumb fixation screw.
- Loosen the horizontal fixed screw, and rotate the instrument by 90 ° , and confirm the vial of the circular vial is at the center at any position.
Correct the vial with the leveling screw when the vial comes off from the center.

[Brightness adjustment of laser]

Neither a state of the surface of ground mark nor a surrounding environmental factor might see the laser spot easily. Please adjust the brightness of the laser if necessary.

P18

If the Laser key is pushed and the laser plummet key is pushed, it becomes the brightness adjustment screen of the laser plummet device.

Adjustment LD plumb power

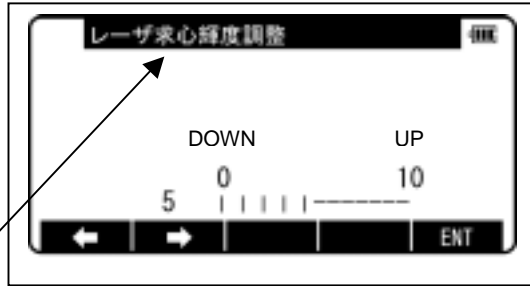

The screen becomes dark by [key] key and becomes bright by [key] key

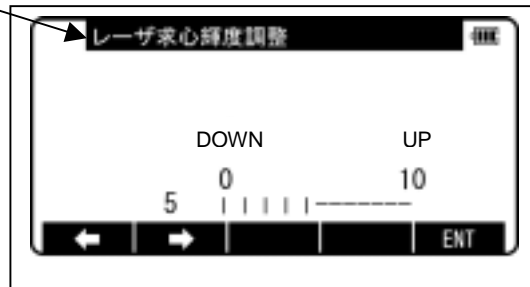

ELECTRONIC VIAL

T. COMP.

The adjustment is completed with the ENT key and it returns to electronic vial screen.

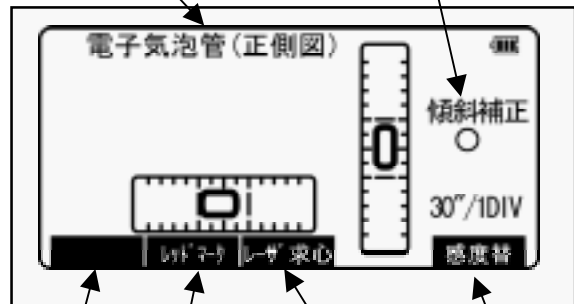

- The brightness adjustment step of the laser is 10%
- Even if the brightness of the laser plummet is adjusted, please check visually it occasionally. In this case, it becomes dark. Please make a few shadows with container case or your hand.
- The laser plummet is adjusted to be within $\pm 0.8\text{mm}$ at the instrument height at factory shipping.
- Please confirm the amount of the gap (direction of Y and X direction) with the laser plummet beforehand compared with plumb bomb etc. with the laser plummet in perpendicular direction using the laser plummet.

TILT LD POINT PLUM.ADJ SENS.

- Please do not look at the laser source of beam directly.



P19

3-4 Leveling with Circular vial

Tripod is matched according to the following points, and expand and contract and match the vial of the Circular vial to the center of the circle.

- Shorten a leg which is the nearest the inclination of the vial or extend the furthest leg and draw the vial to the center.
- The other one leg is put, and next, expand and contract and put the vial in the center. At this time, the foot is not hung to the ferrule and the position of the ferrule does not shift.

3-5 Leveling with Electronic vial [Electronic vial screen]

1. If the Laser key is pushed, it becomes a display screen in the Electronic vial.

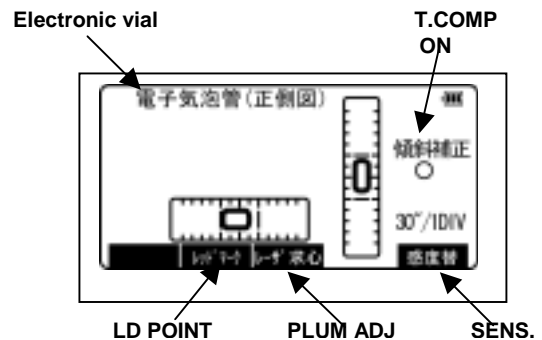

2. It returns to the former screen by the [ESC] key.



- When R-300 instrument is seen at the position of "Left circle position", the screen in the electronic vial becomes a relation with a correct movement of the vial. Please note that the movement of the vial becomes opposite direction if it sees at the position of "Right circle position".
- When instrument is within the tilt compensation range, length and sidewise $\pm 3'$, "ON" is displayed at the right screen, "OVER" is displayed beyond the limits of range and "NIL" is displayed at no compensation setting.
- With command No "520" or "Initial setting 2", when the [TILT DISP] is selected as ON, the [F1 -TILT] of the vial screen becomes effective. The Vial tilt value is indicated when pushing the [TILT] key. With "TILT DISP.UNIT" of the Initial setting 2, 5" or 2" can be selected.

P20

[Leveling]

Rotate instrument horizontally and make two Leveling screws arbitrarily chosen parallel to the display.

Turn on the Electronic vial function by pushing the Laser key. Put the vial of the Circular vial in the center of the circle when it is displayed on the display screen, " TILT OVER "

Turn two Leveling screws arbitrarily chosen in an opposite direction mutually and put the vial of the horizontal Electronic vial in the center. (Figure A)

Put the vial of the lengthwise Electronic vial in the center by operating the Leveling screw of one remainder. (Figure B)

The procedures are different according to the state of the Automatic inclination correction.

[When using the Automatic inclination correction by 2 axes]

Please read procedure because the horizontal angle and the perpendicular angle error by a perpendicular axis are automatically corrected.

[When using the Automatic inclination correction by 1 axis]

The instrument is horizontally rotated by 180 degrees after the vial of an Electronic vial is adjusted on the center at a Left circle position side and confirm that the vial of the vial is at the center at the right circle position.

[When using the Automatic inclination correction by 0 axis]

Confirm the vial is at the center even if the instrument is rotated by each 90° . Confirm whether the instrument is on the ground mark. When you can confirm it is just on the mark loosen the center screw and move the instrument on the ground mark correctly and fix the instrument by a center screw. Repeat from to .

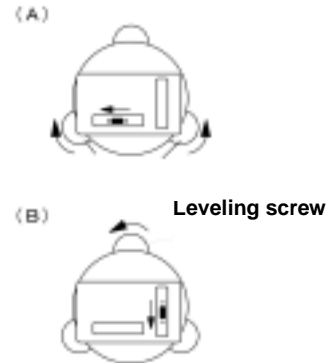

3-6 Eyepiece Adjustment

Eyepiece adjustment

The eyepiece adjustment is performed before target sighting.

Remove the telescope lens cap.

Point the telescope at a bright object, and rotate the eyepiece ring full counter-clockwise.

Look through the eyepiece, and rotate the eyepiece ring clockwise until the reticle appears as its maximum sharpness.

- When looking into the eyepiece, avoid an intense look to prevent parallax and eye fatigue.

When it is hard to see the reticle due to poor brightness, press Illumination key to illuminate it . For adjusting intensity of brightness, refer to page X.

P21

3 PREPARATION FOR SURVEYING•

[Target sighting by Auto focus]

The Auto focus of R-300 series has following two modes.

1. Normal mode : Pressing AF button focuses on the target.
2. Continuous mode : Pressing AF buttons for two seconds beeps, and releasing the key enters into the Continuous mode. This mode enables you to perform the Auto focus approx. for one minutes only by sighting the telescope and chasing the target.

3 PREPARATION FOR SURVEYING

[Auto focus :Target sighting by Normal mode]

q Loosen the telescope clamp and horizontal clamp screws.

w Point the telescope at the target using a collimator.

e Tighten the above two screws.

r Adjust the eyepiece.

t Look through the telescope and press the AF button. Move your eye vertically and horizontally to see if the target image moves in relation to reticle.

y Stay the reticle accurately on the target using telescope and horizontal tangent screws.

If the target image does not move, there is no parallax. If it moves, eliminate the parallax.

Even when vertical angle measurement is not performed, it is recommended that the target should be placed at the reticle center.

Operating the Power focus key rotates the AF ring, so do not touch it while it

3 PREPARATION FOR SURVEYING

[Auto focus :Target sighting by Continuous mode]

Loosen the telescope clamp and horizontal clamp screws.

Point the telescope at the target using a collimator.

Tighten the above two screws.

Adjust the eyepiece.

Look through the telescope and then press the AF button for two seconds to beep, and release the key to enter into the Continuous mode.

Stay the reticle accurately on the target using telescope and horizontal tangent screws.

Point the telescope to the next target as well.

- Keep the target close to the reticle center when chasing it by the Continuous mode.
- Continuous mode automatically ceases after approx. one minute.
- Pressing the AF button or operating the Power focus key releases the continuous mode.
- Operating the Power focus key rotates the AF ring, so do not touch it while it is rotating.

3 PREPARATION FOR SURVEYING

[Auto focus :Target sighting by Power focus mode]

Loosen the telescope clamp and horizontal clamp screws.

Point the telescope at the target using a collimator.

Tighten the above two screws.

Adjust the eyepiece.

Look through the telescope, and then operate the Power focus key and focus on the target.

Stay the reticle accurately on the target using telescope and horizontal tangent screws.

- Tilting the Power focus key "clockwise" makes it possible to focus on closer range and "counterclockwise" makes on further range.
- Tilting angle of the Power focus key makes it possible to perform following Tripod focusing speeds.
Low speed : When tilted to middle position by approx. 5 degrees
Middle speed : When tilted fully by approx. 10 degrees
High speed : When tilted fully by approx. 10 degrees and passed one second
- Operating the Power focus key rotates the AF ring, so do not touch it while it is rotating.

3 PREPARATION FOR SURVEYING

[Target sighting by Manual focus]

Loosen the telescope clamp and horizontal clamp screws.

Point the telescope at the target using a collimator.

Tighten the above two screws.

Adjust the eyepiece.

Look through the telescope and then rotate the AF ring and stop it where the target can be seen clearly and the target image does not move in relation to reticle even if your eye is vertically and horizontally moved.

Stay the reticle accurately on the target using telescope and horizontal tangent screws.

- The AF ring rotation "clockwise" makes it possible to focus on closer range and "counterclockwise" makes it possible to focus on further range.

3 PREPARATION FOR SURVEYING

3- 8 Attachment and Detachment of Tribrach

The tribrach of R-325 is detachable from the instrument if required when replacing the instrument with a target or unit prism for example.

Detachment

First loosen the recessed screw with a screwdriver, then rotate the locking knob until the arrow points upward, and lift the instrument up.

Attachment

Mount the instrument on the tribrach with the guide marks coinciding, and rotate the locking knob until the arrow points downward.

The guide and guide mark must be fitted to attach the instrument

When the tribrach does not need to be attached or detached or instrument is to be transported, tighten the recessed screw with a screwdriver to fix the locking knob.

4 TURNING THE POWER ON

4 TURNING THE POWER ON

4-1 Turning the Power On and Off

Pressing the [POWER] key causes the initial screen.

(The [POWER] key is also used to turn the power off.)

After a few seconds, it turns to Electronic vial screen. Move the vials to center by adjusting the leveling screws.

Pressing the [ENT] key views the angle and distance measurement screen.

- The Auto Power Off function will automatically turn the power off if no operations are performed for approximately 10 minutes. (Factory default setting)
- The [POWER] key is controlled by software in the instrument while it is working, and this key is valid only when turning off causes no problem.
- The value displayed when the power was last time turned off will be displayed for the horizontal angle. If this horizontal angle is not needed, please perform horizontal angle 0 SET.

For details on resetting the horizontal angle 0See page **X**.

For details on changing the horizontal angle from clockwise to counterclockwiseSee page **X**.

For details on measuring the vertical angleSee page **X**.

For details on distance measurementSee page **X**

For details on the automatic power-off functionSee page **X**

For details on the Electronic vial See page **X**

4 TURNING THE POWER ON

4-2 Adjusting LCD Contrast

Press [F4] while holding down the Illumination key to access the screen for **adjusting LCD contrast**.

Pressing [F1] [] will lighten the contrast, while pressing the [F2] [] will darken the contrast.

Press [ENT] to exit adjustment mode and return to the previous screen.

- Pressing the Illumination key views the **F3-RETICLE, F4-LCD and F5-ILLU**.
- LCD contrast may be adjusted as necessary at any time.
- The contrast may be adjusted to any one of 25 levels.
- LCD contrast may be unappealing under certain environmental conditions such as high temperature. Adjust the LCD contrast as described above in such situations.

4 TURNING THE POWER ON

4-3 Adjusting Illumination Brightness

Press [F5] while holding down the Illumination key to access the screen for **adjusting illumination brightness**.

Pressing the [F1] will decrease brightness, while pressing the [F2] will increase brightness.

Press [ENT] to exit adjustment mode and return to the previous screen.

- Pressing the Illumination key views the **F3-RETICLE, F4-LCD and F5-ILLU**.
- Illumination brightness of the LCD screen and telescope reticle may be adjusted as necessary at any time.
- Illumination brightness may be adjusted to any one of 10 levels.

4-4 Adjusting Reticle Illumination

Press [F3] while holding down the Illumination key to access the screen for **adjusting reticle illumination**. The procedure to adjust the reticle illumination is the same way as 4-3.

- Pressing the Illumination key views the **F3-RETICLE, F4-LCD and F5-ILLU**.

Free Manuals Download Website

<http://myh66.com>

<http://usermanuals.us>

<http://www.somanuals.com>

<http://www.4manuals.cc>

<http://www.manual-lib.com>

<http://www.404manual.com>

<http://www.luxmanual.com>

<http://aubethermostatmanual.com>

Golf course search by state

<http://golfingnear.com>

Email search by domain

<http://emailbydomain.com>

Auto manuals search

<http://auto.somanuals.com>

TV manuals search

<http://tv.somanuals.com>